



Submittal Data Sheet

1.5-Ton Floor Standing Unit

FXLQ18MVJU9

FEATURES

- One of our slimmest indoor units (less than 8") fits any interior design
- Wide air discharge outlet distributes a comfortable airflow throughout the entire space
- Silent stream fan technology keeps sound pressure levels low
- Ideal for installation beneath a window
- Unit requires minimal installation space
- Standard Limited Warranty: 10-year warranty on compressor and all parts





Submittal Data Sheet

1.5-Ton Floor Standing Unit

FXLQ18MVJU9

PERFORMANCE

Indoor Unit Model No.	FXLQ18MVJU9	Indoor Unit Name:	1.5-Ton Floor Standing Unit
Type:	Floor Standing	Rated Cooling Conditions:	Indoor (°F DB/WB): 80 / 67 Ambient (°F DB/WB): 95 / 75
Rated Cooling Capacity (Btu/hr):	18,000	Rated Heating Conditions:	Indoor (°F DB/WB): 70 / 70 Ambient (°F DB/WB): 47 / 43
Sensible Capacity (Btu/hr):	12,200	Rated Piping Length(ft):	
Cooling Input Power (kW):	0.110	Rated Height Separation (ft):	
Rated Heating Capacity (Btu/hr):	20,000		
Heating Input Power (kW):	0.11		

INDOOR UNIT DETAILS

Power Supply (V/Hz/Ph):	208-230 / 60 / 1	Airflow Rate (H/L) (CFM):	490/380
Power Supply Connections:	L1, L2, Ground	Moisture Removal (Gal/hr):	
Min. Circuit Amps MCA (A):	0.60	Gas Pipe Connection (inch):	1/2
Max Overcurrent Protection (MOP) (A):		Liquid Pipe Connection (inch):	1/4
Dimensions (HxWxD) (in):	23-5/8 x 55-7/8 x 8-3/4	Condensate Connection (inch):	53/64
Panel (HxWxD) (in):		Sound Pressure (H/L) (dBA):	40/35
Net Weight (lb):	80	Sound Power Level (dBA):	
Panel Weight (lb):		Ext. Static Pressure (Rated/Max) (inWg):	0.00 / 0.00



Submittal Data Sheet

1.5-Ton Floor Standing Unit

FXLQ18MVJU9

DIMENSIONAL DRAWING

FXLQ18/24MVJU9
Unit (in.)

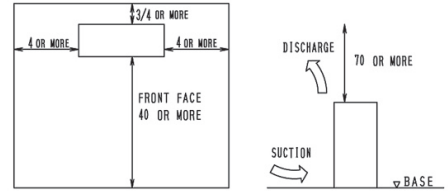
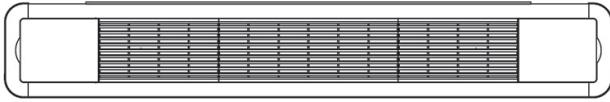

REQUIRED INSTALLATION SPACE

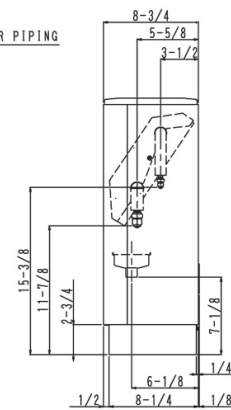
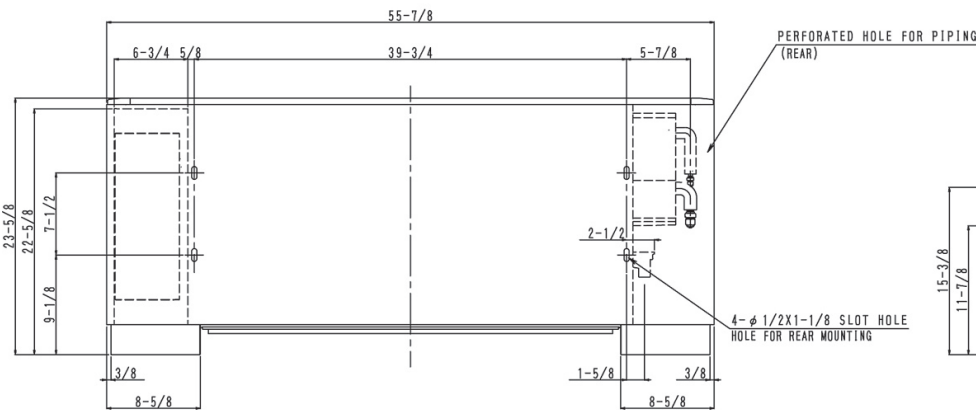

Piping size (Field supply)

Indoor unit	Gas side	Liquid side
FXLQ18MVJU9	φ 1/2	φ 1/4
FXLQ24MVJU9	φ 5/8	φ 3/8

